

# RENAULT GROUP

## KADJAR & CMF C-D



**GROUPE RENAULT**

## DISCLAIMER

Information contained within this document may contain forward looking statements. Although the Company considers that such information and statements are based on reasonable assumptions taken on the date of this report, due to their nature, they can be risky and uncertain (as described in the Renault documentation registered within the French financial markets regulation authorities) and can lead to a difference between the exact figures and those given or deduced from said information and statements.

Renault does not undertake to provide updates or revisions, should any new statements and information be available, should any new specific events occur or for any other reason. Renault makes no representation, declaration or warranty as regards the accuracy, sufficiency, adequacy, effectiveness and genuineness of any statements and information contained in this report.

Further information on Renault can be found on Renault's website ([www.group.renault.com](http://www.group.renault.com)), in the section Finance / Regulated Information.



# REMINDER: WHAT IS CMF CONCEPT?

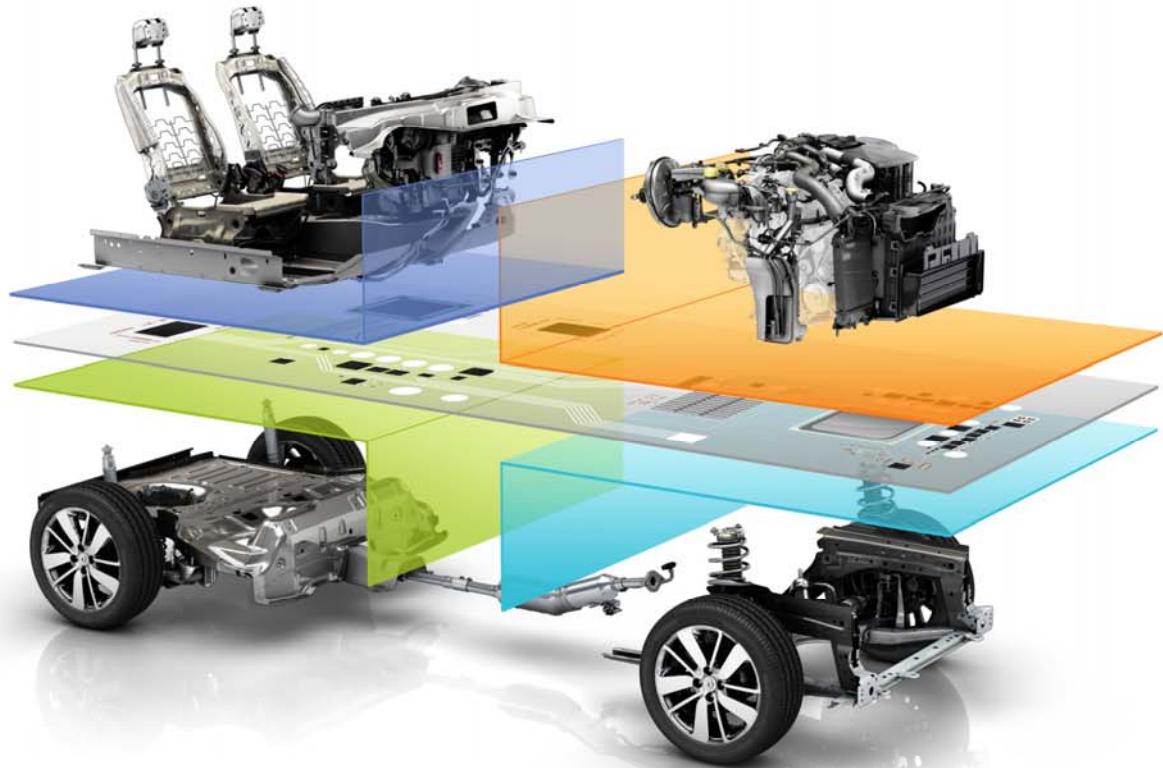

# REMINDER: CMF & PLATFORMS

## SUV



## MPV



## SED



## H/B

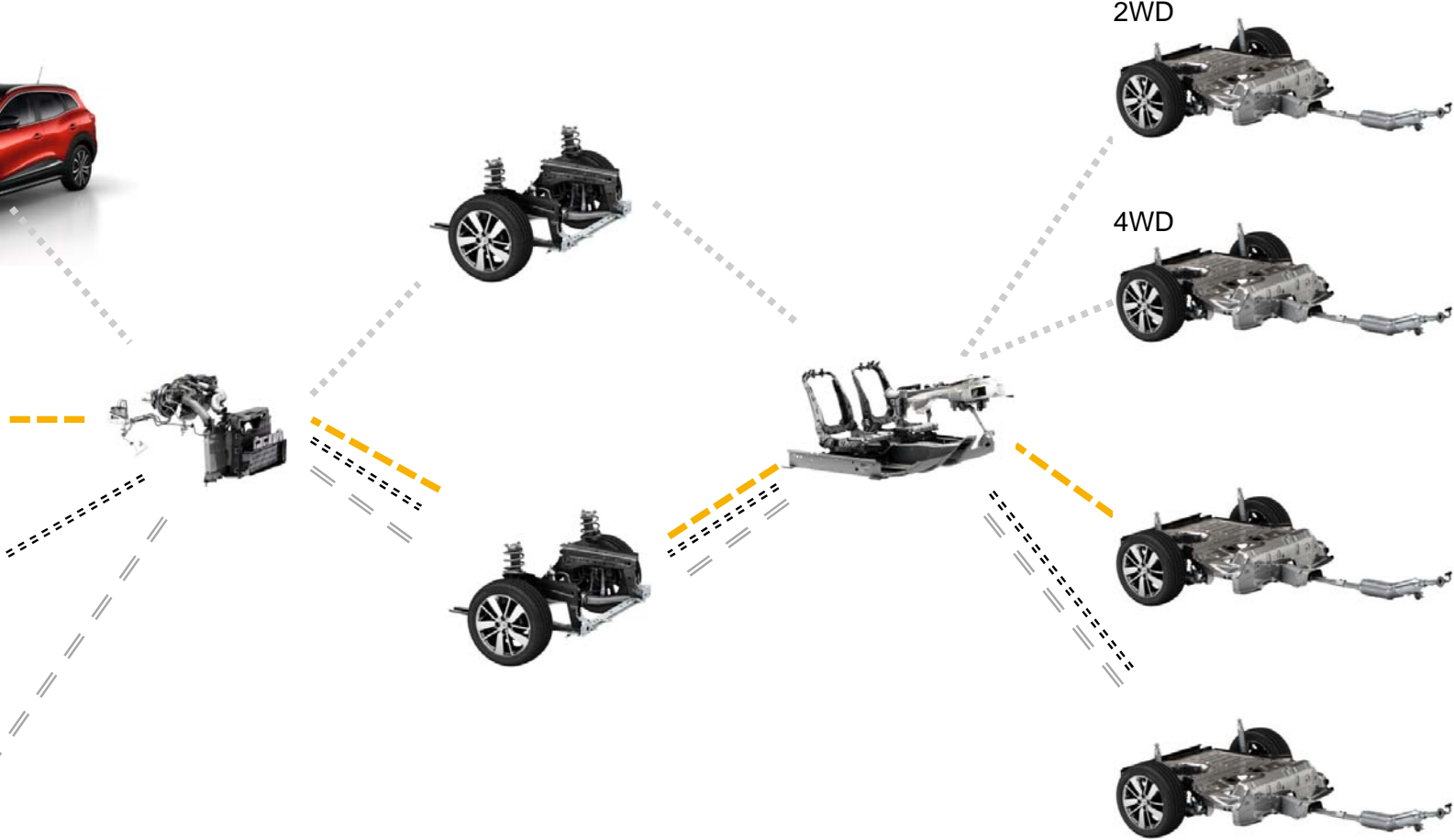

INVESTOR RELATIONS  
KADJAR TEST DRIVE

JUNE 18, 2015

PROPERTY OF GROUPE RENAULT

4

**GROUPE RENAULT**

# REMINDER: CMF A GLOBAL PLATFORM SYSTEM FOR THE ALLIANCE

## 80% OF RENAULT GROUP FUTURE LAUNCHES

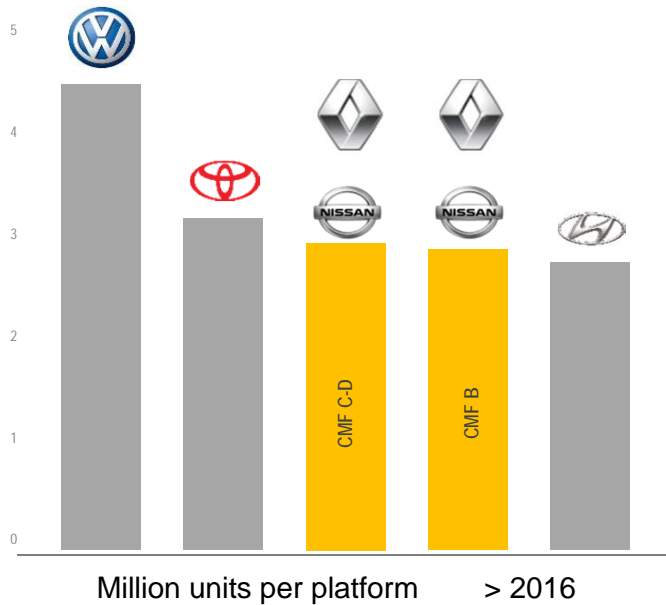

Source : VAG,Hyundai,Toyota : IHS / R&N : Alliance plan

## CMF C-D PRODUCTS



- ESPACE
  - KADJAR
  - D-SEDAN
  - MEGANE
  - D-CROSS OVER
  - ...
- QASHQAI
  - ROGUE
  - X-TRAIL
  - ...



# REMINDER: WHAT ARE THE EXPECTED BENEFITS?



---

## COST REDUCTIONS



# KADJAR: THE FIRST RENAULT C-SEGMENT CAR BASED ON CMF C-D A RENAULT DESIGNED SKIN ON AN ALLIANCE PLATFORM

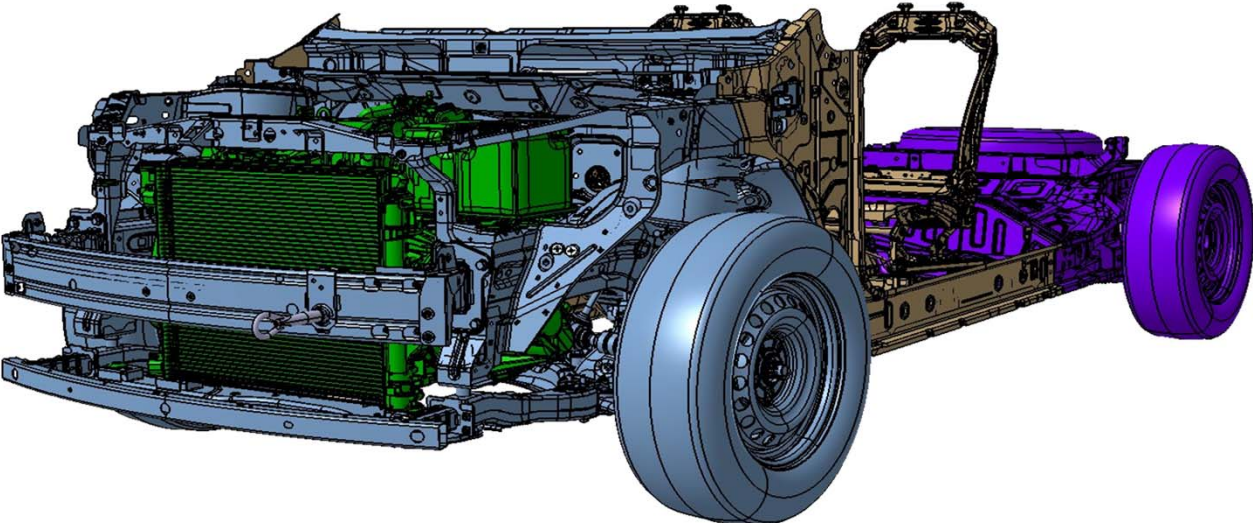

INVESTOR RELATIONS  
KADJAR TEST DRIVE

JUNE 18, 2015

PROPERTY OF GROUPE RENAULT

7

**GROUPE RENAULT**



**KADJAR: THE FIRST RENAULT C-SEGMENT CAR BASED ON CMF C-D**  
**A RENAULT DESIGNED SKIN ON AN ALLIANCE PLATFORM**

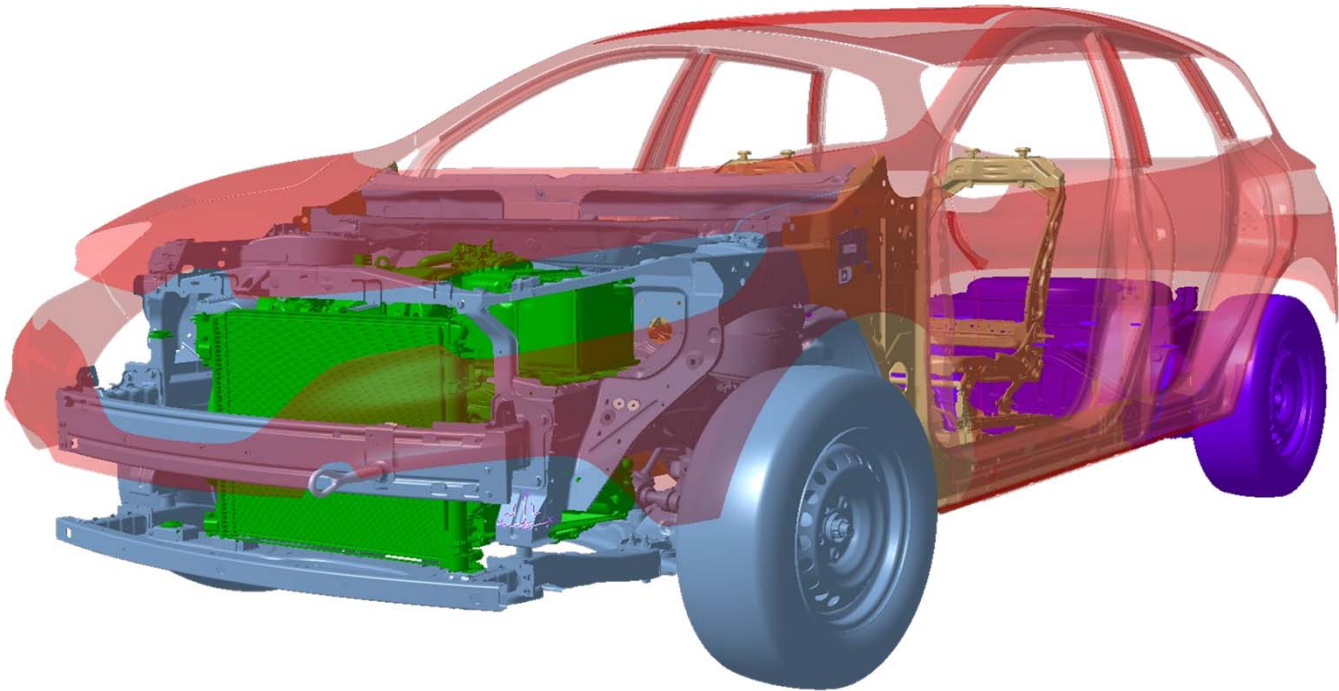

INVESTOR RELATIONS  
KADJAR TEST DRIVE

JUNE 18, 2015

PROPERTY OF GROUPE RENAULT

8

**GROUPE RENAULT**



**KADJAR: THE FIRST RENAULT C-SEGMENT CAR BASED ON CMF C-D**  
**A RENAULT DESIGNED SKIN ON AN ALLIANCE PLATFORM**



INVESTOR RELATIONS  
KADJAR TEST DRIVE

JUNE 18, 2015

PROPERTY OF GROUPE RENAULT

9

**GROUPE RENAULT**

# KADJAR: THE FIRST RENAULT C-SEGMENT CAR BASED ON CMF C-D

## A GLOBAL SYSTEM THAT ADDRESSES LOCAL SPECIFICATIONS

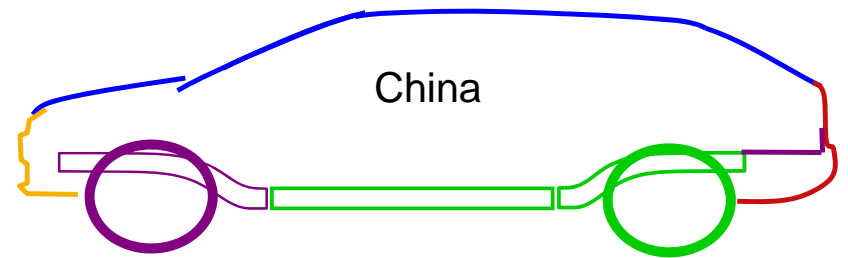
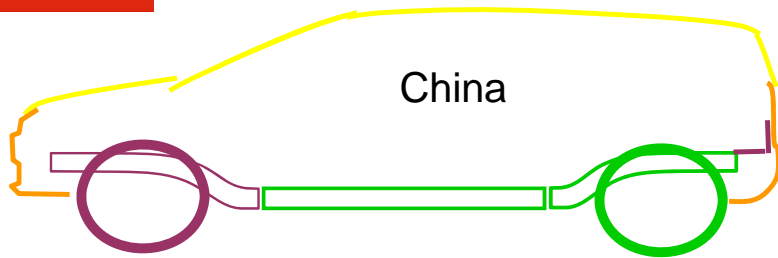
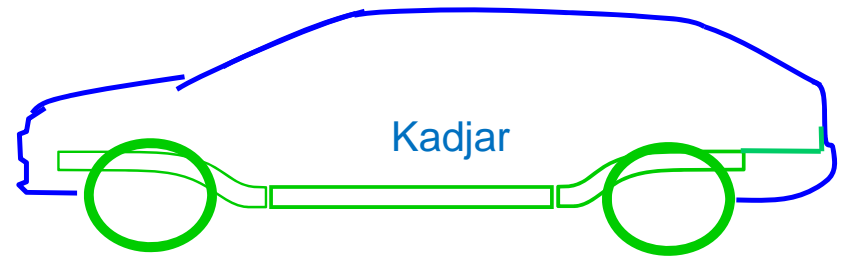
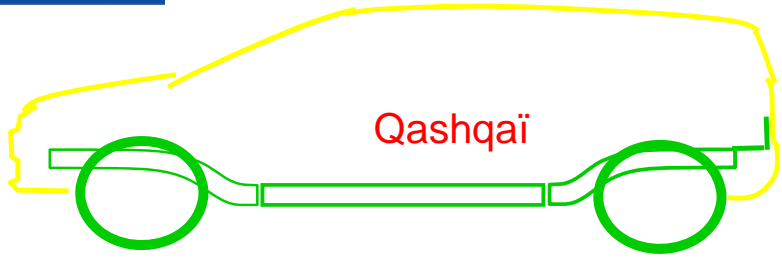

# CMF C-D : RENAULT LINE-UP OPTIMISATION

## C-D SEGMENT RENEWAL

PREVIOUS GENERATION

**14**  
Bodies  
based on  
multiple  
PFs

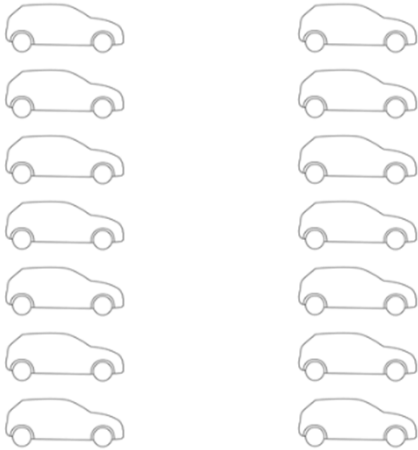

NEW GENERATION

**10**  
Bodies  
based on  
CMF

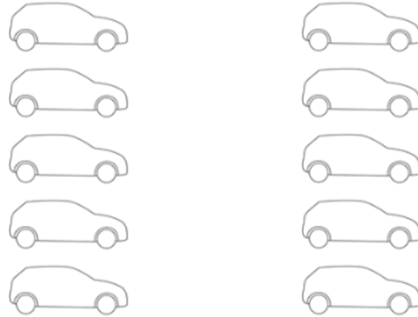

# COST REDUCTION

## ENTRY TICKET (w/o China)

	C&D PREVIOUS PROGRAM	C&D PROGRAM CMF BASED
BODIES	14	10
VOLUMES (Life cycle)	~5m	~5m

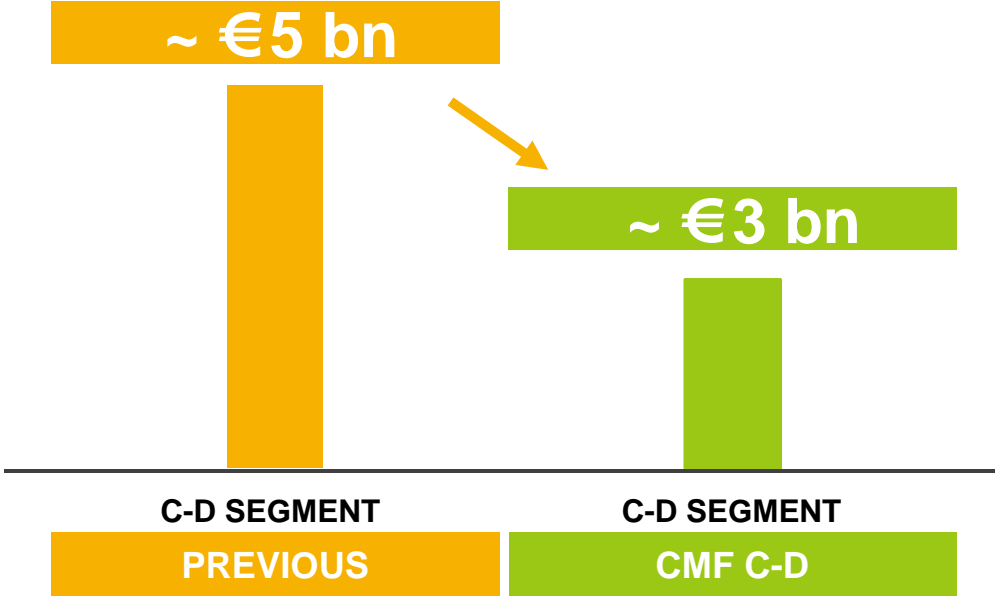

# CMF C-D: IMPROVED PRODUCT QUALITY COST OF WARRANTY

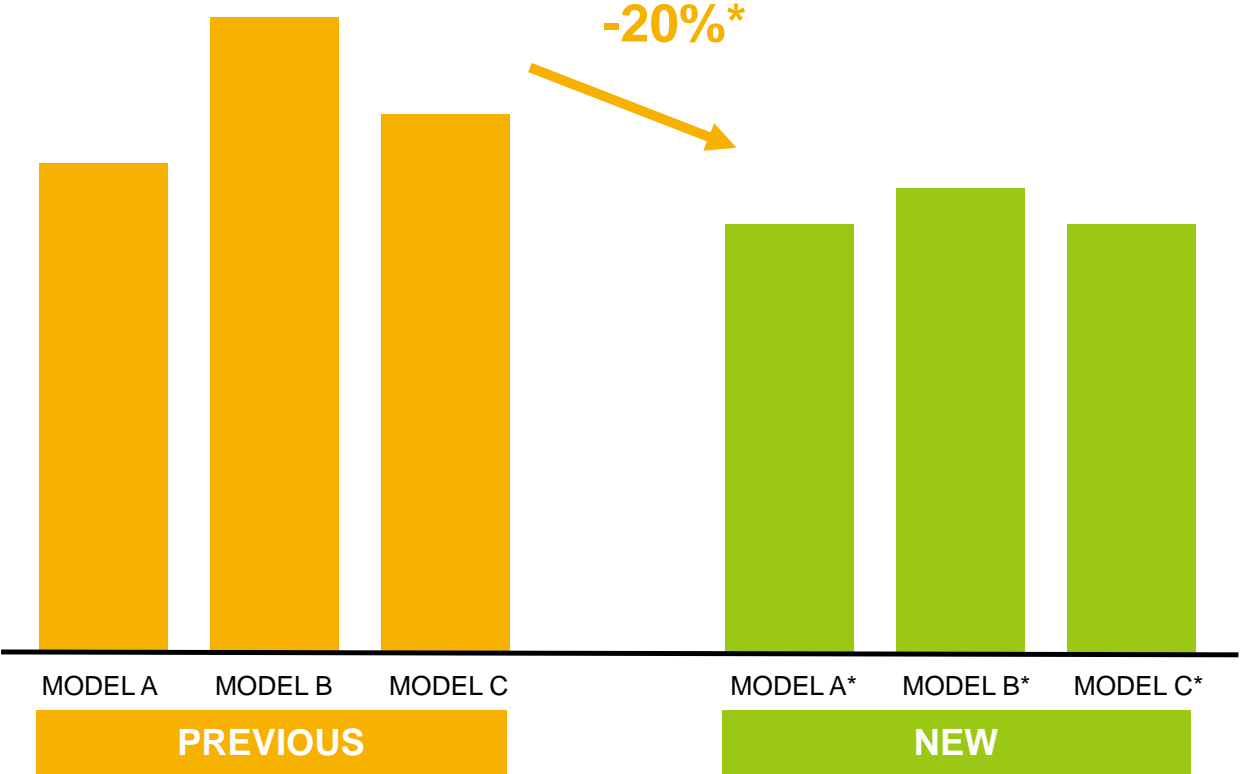

\* Forecast



# CMF C-D: IMPROVED COST STRUCTURE

## CMF COST BENEFITS

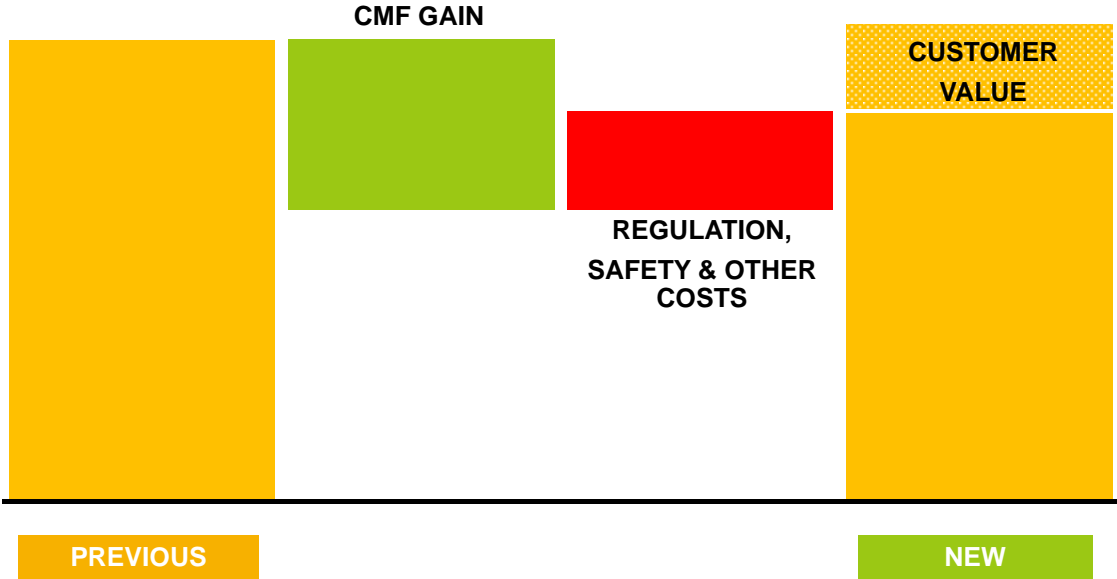

**Better cost structure permits higher customer value**





# LEVERAGING CMF C-D

A NEW STEP TOWARDS GROUP OPERATING MARGIN >5%\*

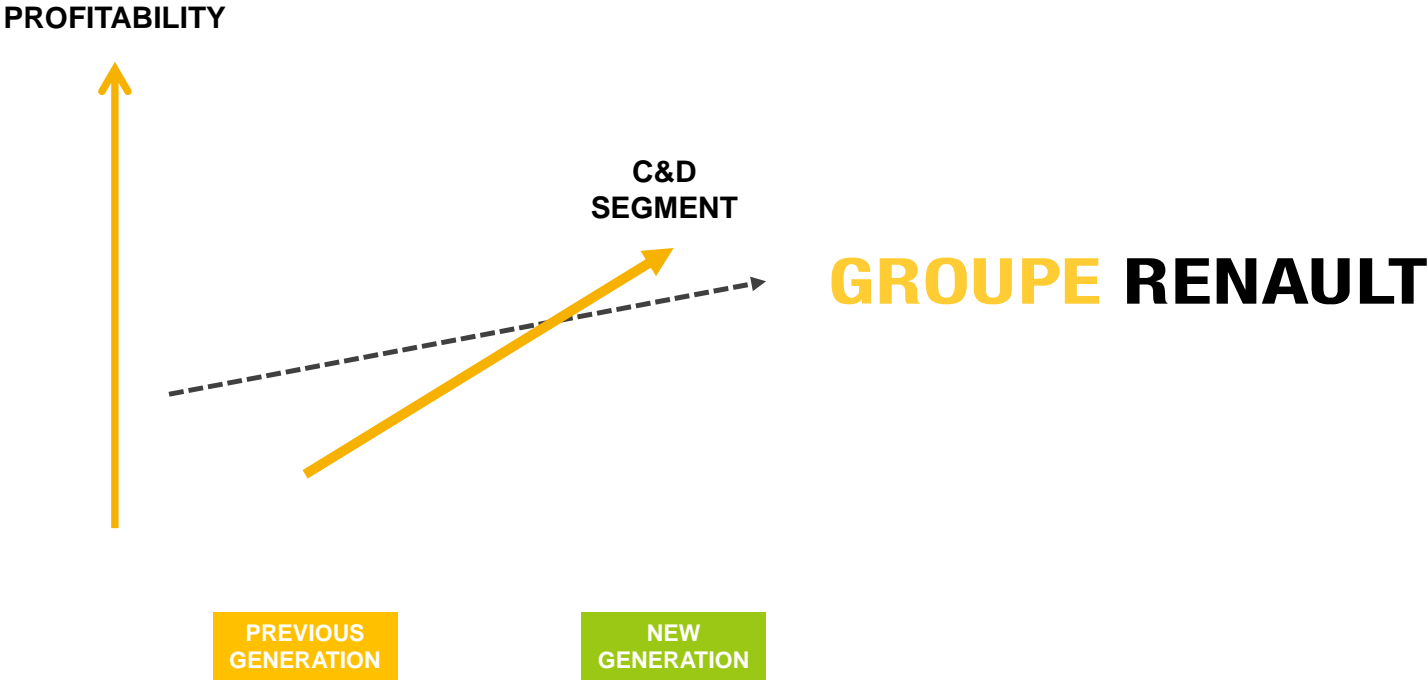

\* Measured in 2017



# Q&A

